



## 6-Pin DIP Optoisolators Transistor Output

The 4N25, 4N26, 4N27 and 4N28 devices consist of a gallium arsenide infrared emitting diode optically coupled to a monolithic silicon phototransistor detector.

- Most Economical Optoisolator Choice for Medium Speed, Switching Applications
- Meets or Exceeds All JEDEC Registered Specifications
- **To order devices that are tested and marked per VDE 0884 requirements, the suffix "V" must be included at end of part number. VDE 0884 is a test option.**

### Applications

- General Purpose Switching Circuits
- Interfacing and coupling systems of different potentials and impedances
- I/O Interfacing
- Solid State Relays

### MAXIMUM RATINGS ( $T_A = 25^\circ\text{C}$ unless otherwise noted)

Rating	Symbol	Value	Unit
--------	--------	-------	------

#### INPUT LED

Reverse Voltage	$V_R$	3	Volts
Forward Current — Continuous	$I_F$	60	mA
LED Power Dissipation @ $T_A = 25^\circ\text{C}$ with Negligible Power in Output Detector Derate above $25^\circ\text{C}$	$P_D$	120	mW
		1.41	mW/ $^\circ\text{C}$

#### OUTPUT TRANSISTOR

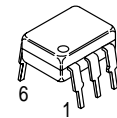
Collector–Emitter Voltage	$V_{CEO}$	30	Volts
Emitter–Collector Voltage	$V_{ECO}$	7	Volts
Collector–Base Voltage	$V_{CBO}$	70	Volts
Collector Current — Continuous	$I_C$	150	mA
Detector Power Dissipation @ $T_A = 25^\circ\text{C}$ with Negligible Power in Input LED Derate above $25^\circ\text{C}$	$P_D$	150	mW
		1.76	mW/ $^\circ\text{C}$

#### TOTAL DEVICE

Isolation Surge Voltage <sup>(1)</sup> (Peak ac Voltage, 60 Hz, 1 sec Duration)	$V_{ISO}$	7500	Vac(pk)
Total Device Power Dissipation @ $T_A = 25^\circ\text{C}$ Derate above $25^\circ\text{C}$	$P_D$	250 2.94	mW mW/ $^\circ\text{C}$
Ambient Operating Temperature Range	$T_A$	-55 to +100	$^\circ\text{C}$
Storage Temperature Range	$T_{stg}$	-55 to +150	$^\circ\text{C}$
Soldering Temperature (10 sec, 1/16" from case)	$T_L$	260	$^\circ\text{C}$

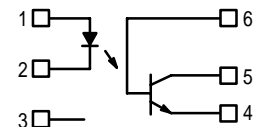
1. Isolation surge voltage is an internal device dielectric breakdown rating.  
For this test, Pins 1 and 2 are common, and Pins 4, 5 and 6 are common.

4N25  
4N26  
4N27  
4N28



STANDARD THRU HOLE

### SCHEMATIC



- PIN 1. LED ANODE  
2. LED CATHODE  
3. N.C.  
4. EMITTER  
5. COLLECTOR  
6. BASE

**ELECTRICAL CHARACTERISTICS** ( $T_A = 25^\circ\text{C}$  unless otherwise noted)<sup>(1)</sup>

Characteristic	Symbol	Min	Typ <sup>(1)</sup>	Max	Unit
----------------	--------	-----	--------------------	-----	------

**INPUT LED**

Forward Voltage ( $I_F = 10\text{ mA}$ )	$T_A = 25^\circ\text{C}$ $T_A = -55^\circ\text{C}$ $T_A = 100^\circ\text{C}$	$V_F$	— — —	1.15 1.3 1.05	1.5 — —	Volts
Reverse Leakage Current ( $V_R = 3\text{ V}$ )		$I_R$	—	—	100	$\mu\text{A}$
Capacitance ( $V = 0\text{ V}$ , $f = 1\text{ MHz}$ )		$C_J$	—	18	—	pF

**OUTPUT TRANSISTOR**

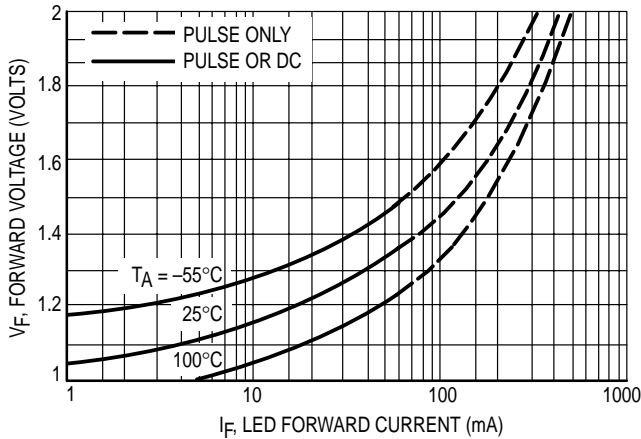
Collector–Emitter Dark Current ( $V_{CE} = 10\text{ V}$ , $T_A = 25^\circ\text{C}$ )	4N25,26,27 4N28	$I_{CEO}$	— —	1 1	50 100	nA
( $V_{CE} = 10\text{ V}$ , $T_A = 100^\circ\text{C}$ )	All Devices	$I_{CEO}$	—	1	—	$\mu\text{A}$
Collector–Base Dark Current ( $V_{CB} = 10\text{ V}$ )		$I_{CBO}$	—	0.2	—	nA
Collector–Emitter Breakdown Voltage ( $I_C = 1\text{ mA}$ )		$V_{(BR)CEO}$	30	45	—	Volts
Collector–Base Breakdown Voltage ( $I_C = 100\text{ }\mu\text{A}$ )		$V_{(BR)CBO}$	70	100	—	Volts
Emitter–Collector Breakdown Voltage ( $I_E = 100\text{ }\mu\text{A}$ )		$V_{(BR)ECO}$	7	7.8	—	Volts
DC Current Gain ( $I_C = 2\text{ mA}$ , $V_{CE} = 5\text{ V}$ )		$h_{FE}$	—	500	—	—
Collector–Emitter Capacitance ( $f = 1\text{ MHz}$ , $V_{CE} = 0$ )		$C_{CE}$	—	7	—	pF
Collector–Base Capacitance ( $f = 1\text{ MHz}$ , $V_{CB} = 0$ )		$C_{CB}$	—	19	—	pF
Emitter–Base Capacitance ( $f = 1\text{ MHz}$ , $V_{EB} = 0$ )		$C_{EB}$	—	9	—	pF

**COUPLED**

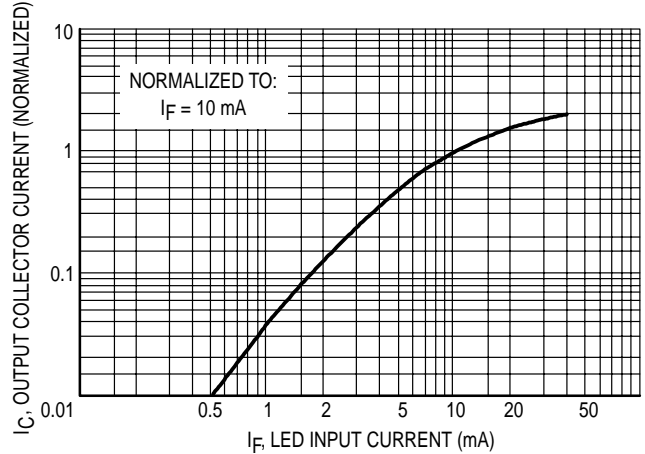
Output Collector Current ( $I_F = 10\text{ mA}$ , $V_{CE} = 10\text{ V}$ )	4N25,26 4N27,28	$I_C$ (CTR) <sup>(2)</sup>	2 (20) 1 (10)	7 (70) 5 (50)	— —	mA (%)
Collector–Emitter Saturation Voltage ( $I_C = 2\text{ mA}$ , $I_F = 50\text{ mA}$ )		$V_{CE(sat)}$	—	0.15	0.5	Volts
Turn–On Time ( $I_F = 10\text{ mA}$ , $V_{CC} = 10\text{ V}$ , $R_L = 100\text{ }\Omega$ ) <sup>(3)</sup>		$t_{on}$	—	2.8	—	$\mu\text{s}$
Turn–Off Time ( $I_F = 10\text{ mA}$ , $V_{CC} = 10\text{ V}$ , $R_L = 100\text{ }\Omega$ ) <sup>(3)</sup>		$t_{off}$	—	4.5	—	$\mu\text{s}$
Rise Time ( $I_F = 10\text{ mA}$ , $V_{CC} = 10\text{ V}$ , $R_L = 100\text{ }\Omega$ ) <sup>(3)</sup>		$t_r$	—	1.2	—	$\mu\text{s}$
Fall Time ( $I_F = 10\text{ mA}$ , $V_{CC} = 10\text{ V}$ , $R_L = 100\text{ }\Omega$ ) <sup>(3)</sup>		$t_f$	—	1.3	—	$\mu\text{s}$
Isolation Voltage ( $f = 60\text{ Hz}$ , $t = 1\text{ sec}$ ) <sup>(4)</sup>		$V_{ISO}$	7500	—	—	Vac(pk)
Isolation Resistance ( $V = 500\text{ V}$ ) <sup>(4)</sup>		$R_{ISO}$	$10^{11}$	—	—	$\Omega$
Isolation Capacitance ( $V = 0\text{ V}$ , $f = 1\text{ MHz}$ ) <sup>(4)</sup>		$C_{ISO}$	—	0.2	—	pF

1. Always design to the specified minimum/maximum electrical limits (where applicable).
2. Current Transfer Ratio (CTR) =  $I_C/I_F \times 100\%$ .
3. For test circuit setup and waveforms, refer to Figure 11.
4. For this test, Pins 1 and 2 are common, and Pins 4, 5 and 6 are common.

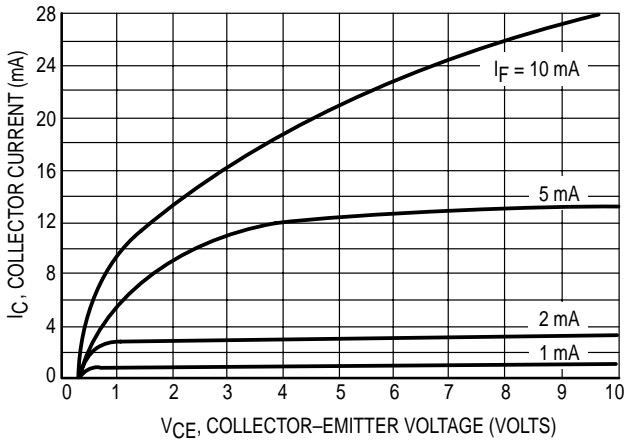
**TYPICAL CHARACTERISTICS**



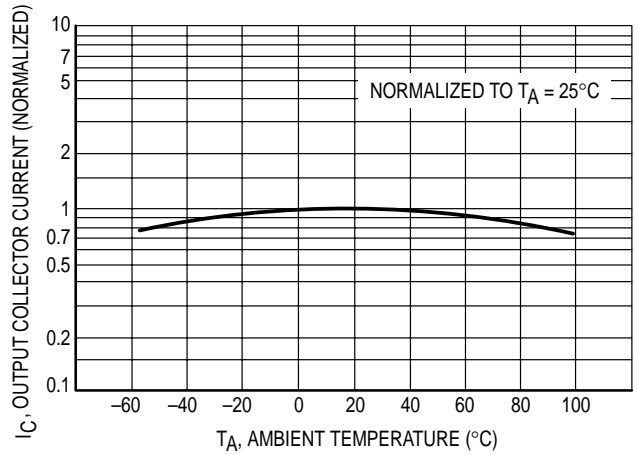
**Figure 1. LED Forward Voltage versus Forward Current**



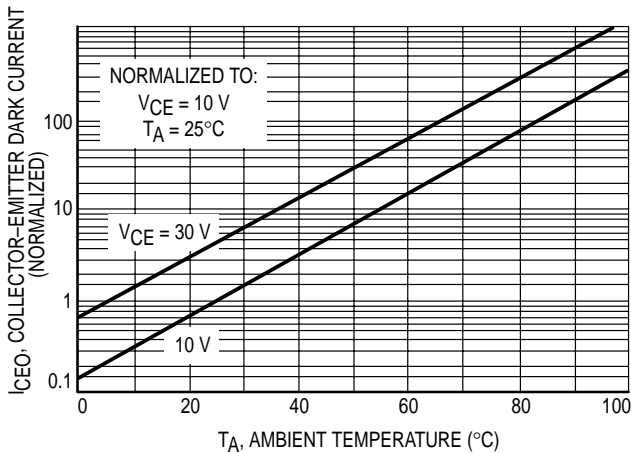
**Figure 2. Output Current versus Input Current**



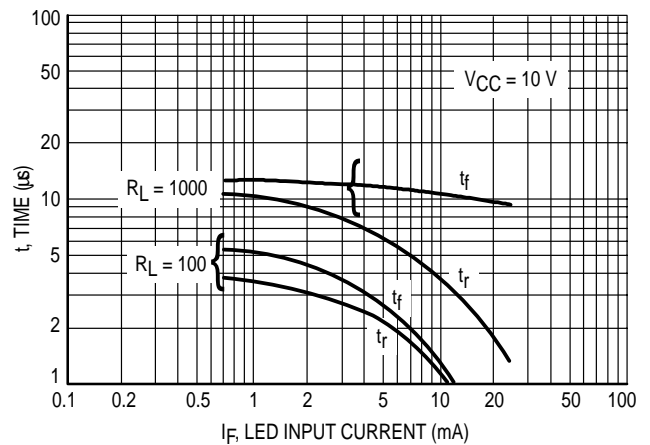
**Figure 3. Collector Current versus Collector-Emitter Voltage**



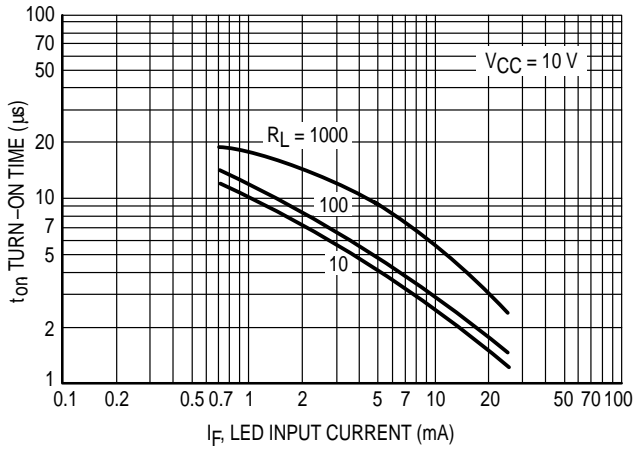
**Figure 4. Output Current versus Ambient Temperature**



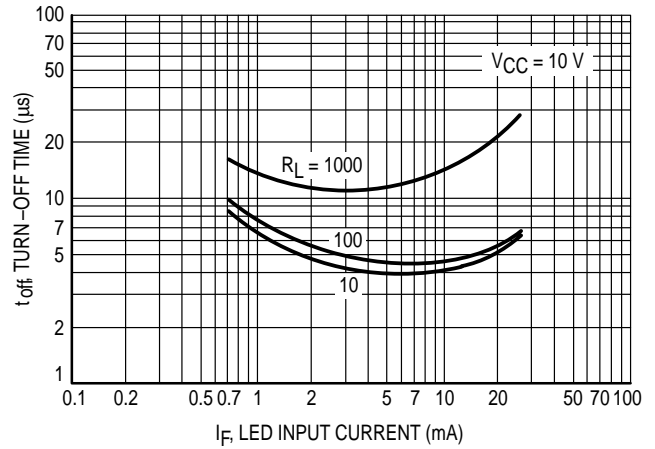
**Figure 5. Dark Current versus Ambient Temperature**



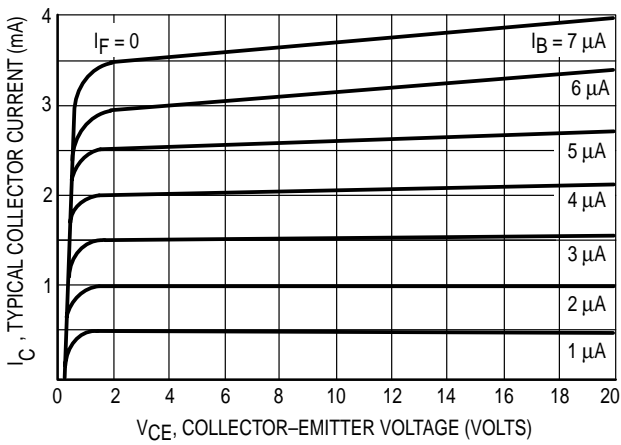
**Figure 6. Rise and Fall Times (Typical Values)**



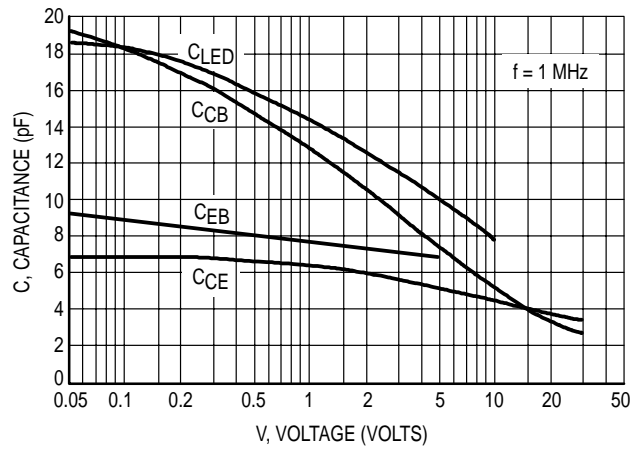
**Figure 7. Turn-On Switching Times (Typical Values)**



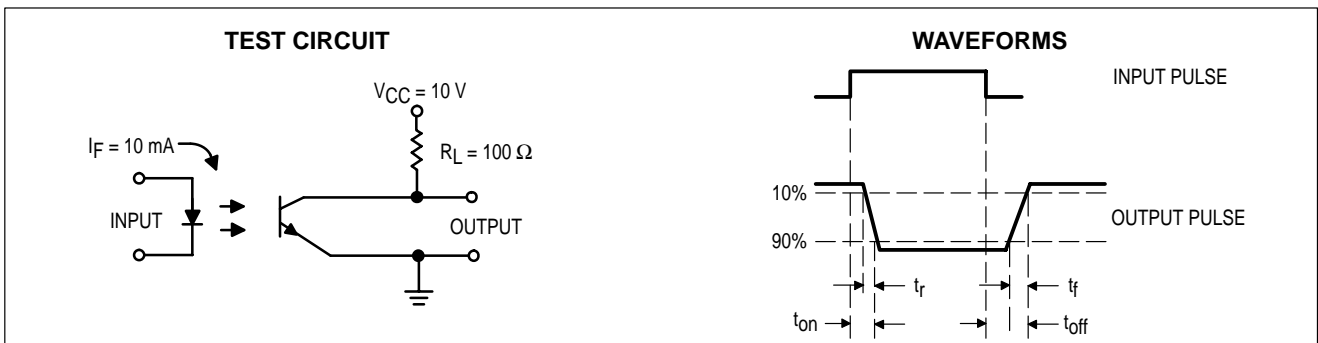
**Figure 8. Turn-Off Switching Times (Typical Values)**



**Figure 9. DC Current Gain (Detector Only)**

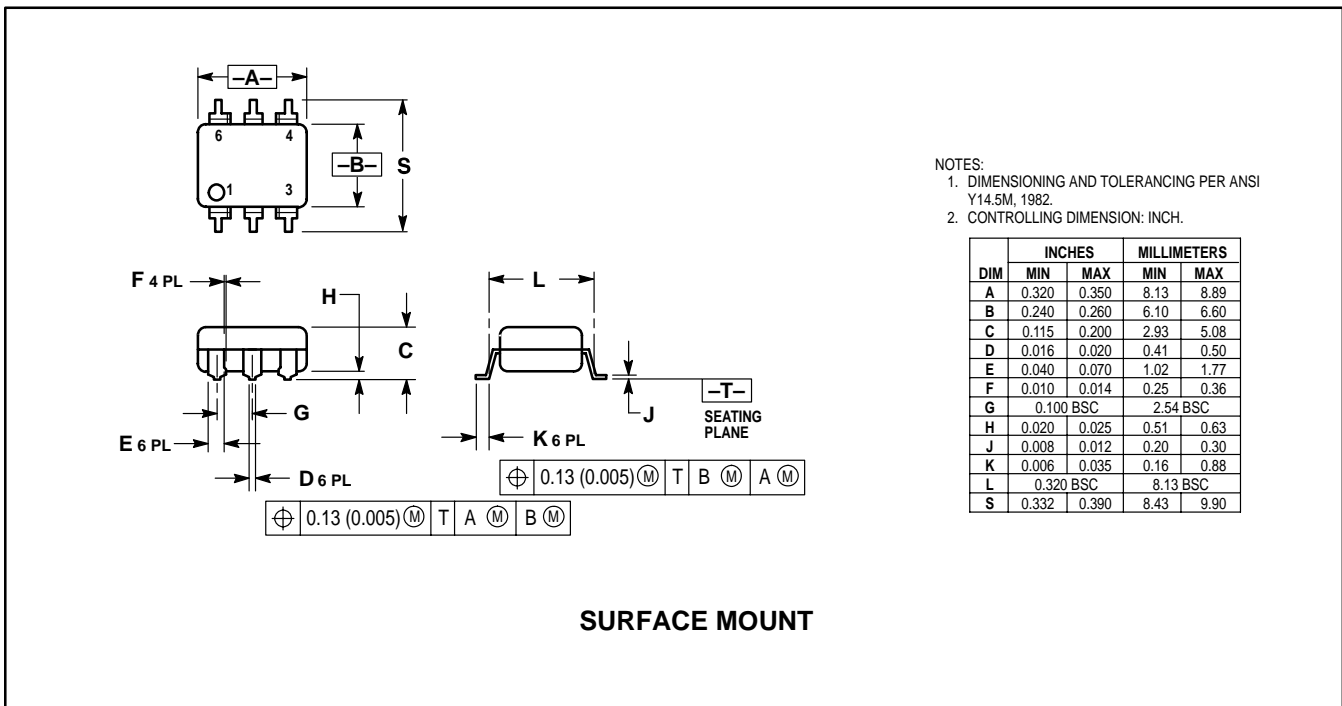
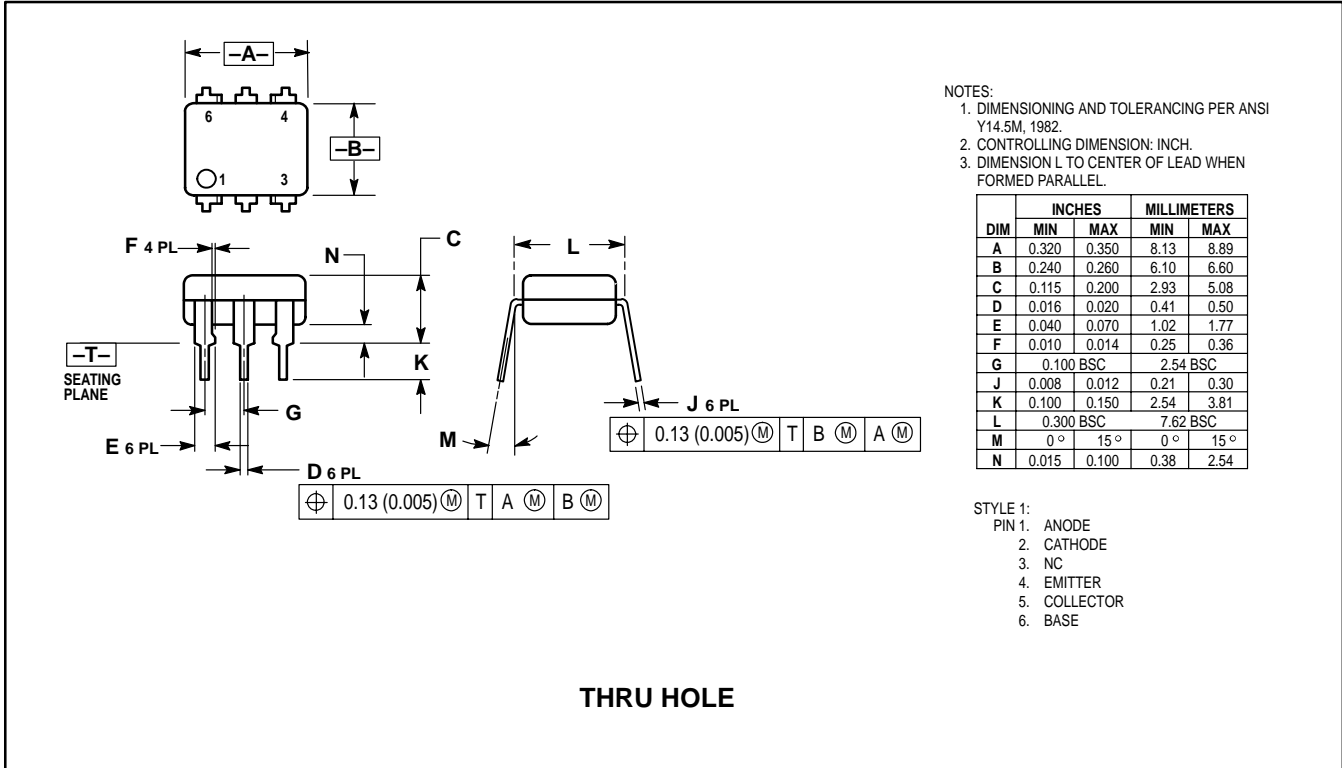


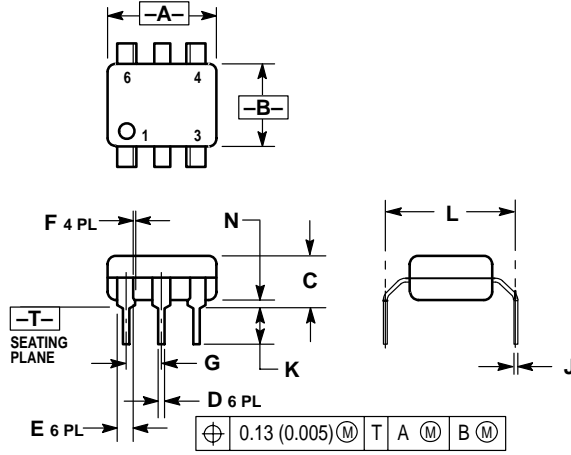
**Figure 10. Capacitances versus Voltage**



**Figure 11. Switching Time Test Circuit and Waveforms**

**PACKAGE DIMENSIONS**





- NOTES:
1. DIMENSIONING AND TOLERANCING PER ANSI Y14.5M, 1982.
  2. CONTROLLING DIMENSION: INCH.
  3. DIMENSION L TO CENTER OF LEAD WHEN FORMED PARALLEL.

DIM	INCHES		MILLIMETERS	
	MIN	MAX	MIN	MAX
A	0.320	0.350	8.13	8.89
B	0.240	0.260	6.10	6.60
C	0.115	0.200	2.93	5.08
D	0.016	0.020	0.41	0.50
E	0.040	0.070	1.02	1.77
F	0.010	0.014	0.25	0.36
G	0.100 BSC		2.54 BSC	
J	0.008	0.012	0.21	0.30
K	0.100	0.150	2.54	3.81
L	0.400	0.425	10.16	10.80
N	0.015	0.040	0.38	1.02

**0.4" LEAD SPACING**

**DISCLAIMER**

FAIRCHILD SEMICONDUCTOR RESERVES THE RIGHT TO MAKE CHANGES WITHOUT FURTHER NOTICE TO ANY PRODUCTS HEREIN TO IMPROVE RELIABILITY, FUNCTION OR DESIGN. FAIRCHILD DOES NOT ASSUME ANY LIABILITY ARISING OUT OF THE APPLICATION OR USE OF ANY PRODUCT OR CIRCUIT DESCRIBED HEREIN; NEITHER DOES IT CONVEY ANY LICENSE UNDER ITS PATENT RIGHTS, NOR THE RIGHTS OF OTHERS.

**LIFE SUPPORT POLICY**

FAIRCHILD'S PRODUCTS ARE NOT AUTHORIZED FOR USE AS CRITICAL COMPONENTS IN LIFE SUPPORT DEVICES OR SYSTEMS WITHOUT THE EXPRESS WRITTEN APPROVAL OF THE PRESIDENT OF FAIRCHILD SEMICONDUCTOR CORPORATION. As used herein:

1. Life support devices or systems are devices or systems which, (a) are intended for surgical implant into the body, or (b) support or sustain life, and (c) whose failure to perform when properly used in accordance with instructions for use provided in the labeling, can be reasonably expected to result in a significant injury of the user.
2. A critical component in any component of a life support device or system whose failure to perform can be reasonably expected to cause the failure of the life support device or system, or to affect its safety or effectiveness.